

INFRARED GAS ANALYZER

DATA SHEET

ZRE

This gas analyzer (ZRE) is capable of measuring the concentration of NO, SO₂, CO₂, CO, CH₄ and O₂ components in sample gas. NO, SO₂, CO₂, CO and CH₄ are measured by non-dispersion infrared method (NDIR), while O₂ is measured by fuel cell, or zirconia method. Up to 5 components including O₂ can be measured simultaneously.

This analyzer is designed with smaller physical dimensions. It is well suited for compact analyzing system designs. In addition maintenance is simplified through adoption of the single-beam system.

Optimum use as an analyzer unit of measurement system for combustion exhaust gas from refuse incinerator and boiler, or gas from various industrial furnaces.



FEATURES

1. Small and light

The size is small 133×483×418mm (H×W×D) and light (8kg).

But it is capable max. 5 component measurement in one analyzer.

2. Easy maintenance

Because of single-beam system the measurement unit is simple with no need for optical adjustment. Therefore, maintenance is easy.

3. Easy operation

Operation can be carried out smoothly in an interactive way through a large-size LCD.

4. Abundant functions

Various optional functions are available such as auto calibration control, high and low concentration alarm, remote range switch, and range identification signal, etc.

SPECIFICATIONS

Standard Specifications

Principle of measurement:

- NO, SO₂, CO₂, CO, CH₄ ;
Non-dispersion infrared-ray absorption method
Single light source and single beams (single beam system)
- O₂ ; Fuel cell O₂ sensor (built in) or zirconia O₂ sensor (externally installed TYPE: ZFK7) (Built in paramagnetic O₂ sensor will be next revision.)

Measurable gas components and measuring range:

	Minimum range	Maximum range
NO	0 - 200ppm	0 - 5000ppm
SO ₂	0 - 200ppm	0 - 10vol%
CO ₂	0 - 100ppm	0 - 100vol%
CO	0 - 200ppm	0 - 100vol%
CH ₄	0 - 500ppm	0 - 100vol%
O ₂ (built in fuel cell)	0 - 10vol%	0 - 25vol%
O ₂ (External Zirconia)	0 - 5vol%	0 - 25vol%

(Note) Built-in magnetic O₂ sensor is available in the near future.

- Max. 5 components measurement including O₂.
- Measuring range ratio max. 1:10
- Measuring ranges are changeable between the specified minimum and maximum range
Settable one range or two ranges
- For possible combinations of components and ranges, refer to Table1.

Measured value indication:

- Digital indication in 4 digits (LCD with back light)
- Instantaneous value of each component
- Instantaneous value after O₂ correction (only in NO, SO₂, CO measurement with O₂)
- Average value after O₂ correction (only in NO, SO₂, CO measurement with O₂)
- O₂ average value

Analog output signals:

- 4 to 20mA DC or 0 to 1V DC, isolated internally from circuit and ground; 12 outputs max.
- max. load 550Ω for 4 to 20 mA DC
- min. load 100kΩ for 0 to 1V DC
- * Refer to Table2 for the channel No. of displayed values and analog output signals.

Analog input signal:

For signal input from externally installed O₂ sensor.

Signal requirement;

(1) Signal from Fuji's Zirconia O₂ sensor (TYPE: ZFK7)

(2) 0 to 1V DC from an O₂ sensor
Input section is not isolated. This feature is effective when an O₂ sensor is not built in.

* Externally installed O₂ sensor should be purchased separately.

Digital output: (Option)

1c contact (24V DC/1A, resistive load) max.15 outputs

Instrument error, calibration error, range identification, auto calibration status, pump ON/OFF, High/Low limit alarm contact output.

Power disconnection alarm.

* All relay contacts are isolated mutually and from the internal circuit.

Digital input: (Option)

Voltage contact (Supply 12 to 24V DC/15mA max. at ON) max. 9 inputs

Remote range switch, auto calibration remote start, remote holding, average value resetting, pump ON/OFF

Isolated from the internal circuit with photocoupler.

Power supply: Voltage rating ; 100V to 240V AC
Allowable range ; 85V to 264V AC
Frequency ; 50Hz/60Hz
Power consumption ; 100VA max.

Operation conditions:

Ambient temperature;
-5°C to 45°C

(40°C max. when 2 optical system at 200V AC power source)

Ambient humidity ; 90% RH max.,
non-condensing

Storage conditions:

Ambient temperature; -20°C to 60°C
Ambient humidity ; 100% RH max.,
non-condensing

Dimensions (H × W × D):

19-inch rack mounting type:
133 x 483 x 418mm

Panel mounting type:
133 x 443 x 418mm

Mass: Approx. 8 kg

Finish color: Front panel; Black (DIC P 1000-F)
Cool gray (PANTON IC-F)

Casing; Cool gray (PANTON IC-F)

Enclosure: Steel casing, for indoor use

Material of gas-contacting parts:

Gas inlet/outlet; SUS304

Sample cell; SUS304, chloroprene rubber

Infrared-ray transmitting window; CaF₂

O₂ sensor sample cell : SUS316

Internal piping; Toaron, Teflon

Gas inlet/outlet: Rc1/4 or NPT1/4 internal thread

Purge gas flow rate: 1L/min (when required)

Life time of fuel cell O₂ sensor:

2 years

Standard Functions**Output signal holding:**

Output signals are held during manual and auto calibrations by activation of holding (turning "ON" its setting).

The output to be held are the ones just before start calibration mode or setting value.

It is selectable.

Indication of instantaneous values will not be held.

Switch ranges: The switch ranges function is available in manual, auto, and remote modes. Only preset switch method is effective.

Manual: Allows range to switch by key operation.

Auto: Allows range to switch from low to high range when 90%FS or more is available in the low range.

Allows range to switch from high to low range when 80%FS or less is available in the low range.

Remote: Voltage contact input (for measurable components)

(Option) Allows range to switch via an external signal when remote range switch input is received.

When the contact input terminals for each component are input voltage, the first range is selected, and it is switched to the second range when the terminals are open.

Optional Functions**Remote output holding:**

Output signal is held at the latest value or setting value by voltage input the remote output holding input terminals.

Holding is maintained while the voltage input the terminals. Indication of instantaneous values will not be held.

Range identification signal:

The present measuring range is identified by a contact signal.

The contact output terminals for each component turn on when the first range is selected, and when the second range is selected, the terminals are open.

Auto calibration:

Auto calibration is carried out periodically at the preset cycle.

When a standard gas cylinder for calibration and a solenoid valve for opening/closing the gas flow line are prepared externally by the customer, calibration will be carried out with the solenoid valve drive contacts for zero calibration and each span calibration turned on/off sequentially at the set auto calibration timing.

Auto calibration cycle setting:

Auto calibration cycle is set.

Setting is variable within 1 to 99 hours (in increments of 1 hour) or 1 to 40 days (in increments of 1 day).

Gas flow time setting:
The time for flowing each calibration gas in auto calibration is set.
Settable within 60 to 900 seconds (in increments of 1 second)

Auto calibration remote start:
Auto calibration is carried out only once according to an external input signal. Calibration sequence is settable in the same way as the general auto calibration.
Auto calibration is started by opening the auto calibration remote start input terminals after input voltage for 1.5 seconds or longer.

Auto zero calibration:
Auto zero calibration is carried out periodically at the preset cycle.
This cycle is independent on "Auto calibration" cycle.
When zero calibration gas and solenoid valve for opening/closing the calibration gas flow line are prepared externally by the customer, zero calibration will be carried out with the solenoid valve drive contact for zero calibration turned on/off at the set auto zero calibration timing.

Auto zero calibration cycle setting:
Auto zero calibration cycle is set.
Setting is variable within 1 to 99 hours (in increments of 1 hour) or Setting is variable within 1 to 40 days (in increments of 1 day)

Gas flow time setting:
The timing for flowing zero gas in auto zero calibration is set.
Settable 60 to 900 seconds (in increments of 1 second)

High/low limit alarm:
Alarm contact output turns on when measurement value reach the preset high or low limit alarm value.
Contacts turn on when the channel value of each channel exceeds the high alarm limit value or falls below the low alarm limit value.

Instrument error contact output:
Contacts turn on at occurrence of analyzer error No. 1, 2, 3 or 10.

Calibration error contact output:
Contacts turn on at occurrence of manual or auto calibration error (any of errors No. 4 to 9).

Auto calibration status contact outputs:
Contacts turn on during auto calibration.

Pump ON/OFF contact output:
During measurement, this contact turn on. While calibration gas is flowing, this contact off. This contact is connected in power supply of pump, and stop the sample gas while calibration gas flowing.

O₂ correction: Correction of measured NO, SO₂ and CO gas concentrations into values at reference O₂ concentration

Correction formula:

$$C = \frac{21-O_n}{21-O_s} \times C_s$$

C : Sample gas concentration after O₂ correction

C_s : Measured concentration of sample gas

O_s : Measured O₂ concentration (Limit setting: 1 to 20% O₂)

O_v : Reference O₂ concentration (value changeable by setting. 0 to 19% O₂)

Average value after O₂ correction and O₂ average value calculation:

The result of O₂ correction or instantaneous O₂ value can be outputted as an average value in the preset period of time.

Used for averaging is the moving average method in which sampling is carried out at intervals of 30 seconds.

(Output is updated every 30 seconds. It is the average value in the determined period of time just before the latest updating.)

Averaging time is settable within 1 to 59 minutes (in increments of 1 minute) or 1 to 4 hours (in increments of 1 hour).

Average value resetting:

The above-mentioned output of average value is started from the initial state by opening the average value resetting input terminals after input voltage for 1.5 seconds or longer.

Output is reset by input voltage and restarted by opening

Communication function:

RS-485 (9pins D-sub) or USB (Type-B)

Half-duplex bit serial

Start-stop synchronization

Modbus™ protocol

Contents : Read/Write parameters

Read measurement concentration and instrument status

Remark : When connecting via RS-232C interface, an RS-232C ↔ RS-485 converter should be used.

Performance

Repeatability: ±0.5% of full scale
Linearity: ±1% of full scale
Zero drift: ±2% of full scale/week
 In the case of auto zero calibration use for 500 ppm or less range
Span drift: ±2% of full scale/week
Response time (for 90% FS response) :
 1 to 15 sec electrical response
 Within 60 seconds including replacement time of sampling gas (when gas flow rate is 0.5L/min)
 Gas replacement time depends on the number of measuring components, and measuring range.

Interference from other gases:

Interference component	CO ₂ analyzer	CO analyzer	CH ₄ analyzer	SO ₂ analyzer	NO analyzer
CO 1000ppm	≤1%FS	—	≤1%FS	≤1%FS	≤1%FS
CO ₂ 15%	—	≤1%FS (for 200ppm analyzer, ≤2.5%FS)	≤1%FS	≤1%FS	≤2%FS
H ₂ O saturation at 20°C	≤1%FS	≤1%FS (for 500ppm analyzer, ≤2.5%FS)	≤1%FS	—	—
H ₂ O saturation at 2°C	—	≤2.5%FS (for 200ppm analyzer)	—	≤2%FS	≤2%FS
CH ₄ 1000ppm	≤1%FS	≤1%FS	—	≤50ppm	—

EC Directive Compliance

The product conforms to the requirements of the Low Voltage Directive 2006/95/EC and EMC directive 89/336/EEC (as amended by Directive 92/31/EEC), both as amended by Directive 93/68/EEC.

It conforms to following standards for product safety and electromagnetic compatibility ;

EN61010-1 : 2001 Safety requirements for electrical equipment for measurement, control and laboratory use.

“Installation Category II”

“Pollution Degree 2”

EN61326-1 : 1997, A1: 1998, A2: 2001, A3: 2003

Electrical equipment for measurement, control and laboratory use — EMC requirements.

CE

Standard Requirements for Sample Gas

Flow rate: 0.5L / min ±0.2L / min
Temperature: 0 to 50°C
Pressure: 10 kPa or less (Gas outlet side should be open to the atmospheric air.)
Dust: 100 µg/Nm³ or less in particle size of 0.3 µm or less
Mist: Unallowable
Moisture: Below a level where saturation occurs at room temperature (condensation unallowable).
 Below the level where saturation occurs at 2°C for CO measurement in 0 to 200 ppm range, NO measurement, and SO₂ measurement.

Corrosive component:

1 ppm or less

Standard gas for calibration:

Zero gas ; Dry N₂

Span gas ; Each sample gas having concentration 90 to 100% of its measuring range (recommended).

In case a zirconia O₂ analyzer is installed externally and calibration is carried out on the same calibration gas line:

Zero gas ; Dry air or atmospheric air

Span gas ; For other than O₂ measurement, each sample gas having concentration 90 to 100% of its measuring range
 For O₂ measurement, O₂ gas of 1 to 2 vol%/remains N₂ gas

Installation Requirements

- Indoor use (Select a place where the equipment does not receive direct sunlight, draft/rain or radiation from hot substances. If such a place cannot be found, a roof or cover should be prepared for protection.)
- Avoid a place where unit receives heavy vibration
- Select a place where atmospheric air is clean

Principle diagram of NDIR type measurement (For CO₂, CO, CH₄, SO₂, NO)

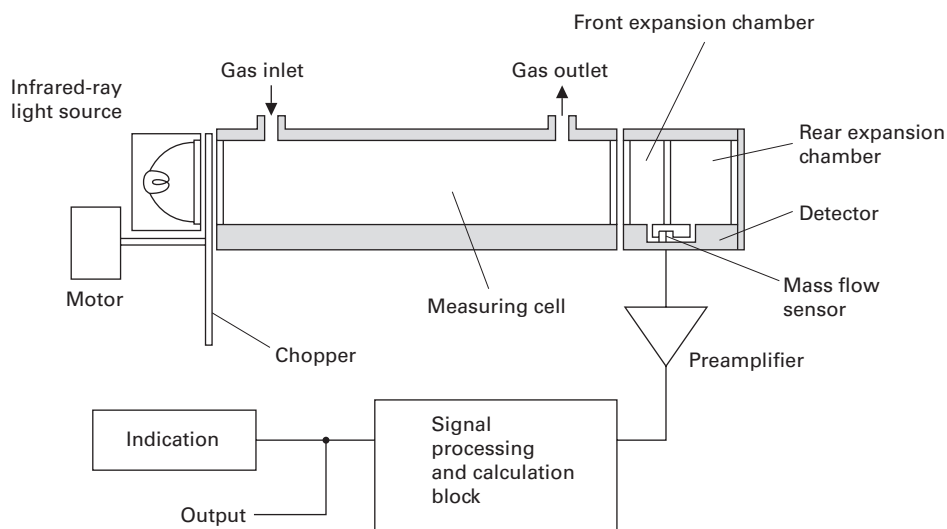

Principle diagram of fuel cell type measurement (For O₂)

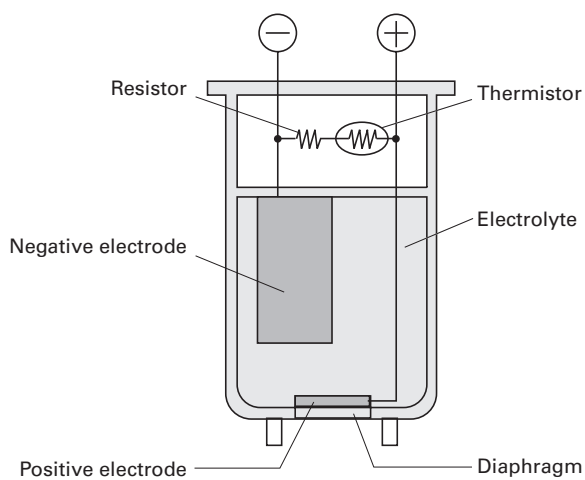

Examples of sampling system configuration including gas analyzer

To measure low moisture content (saturated at room temperature or lower) sample gas (CO, CO₂, CH₄)

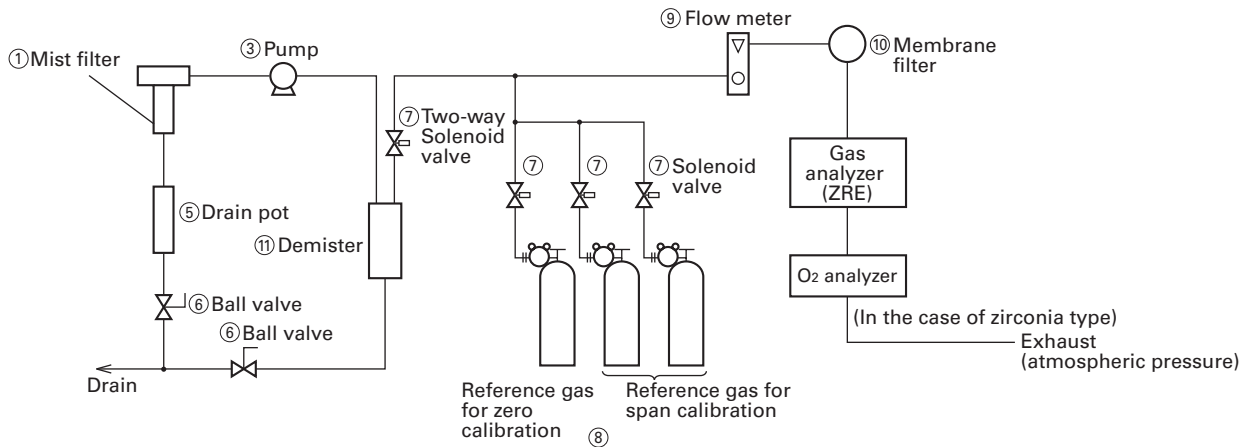

To measure high moisture content sample gas, NO, SO₂, or CO (0 to 200 ppm range)

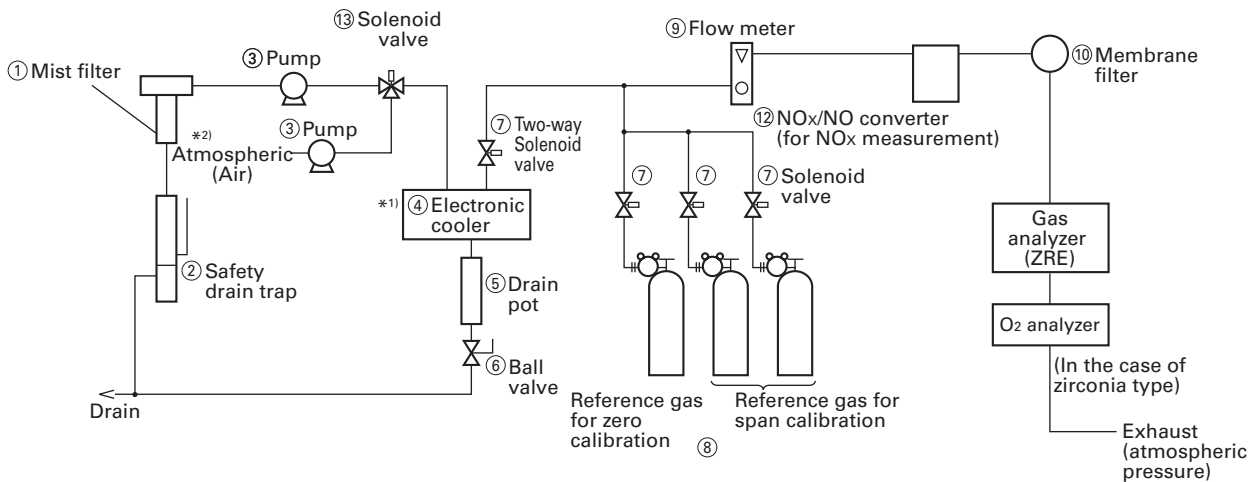

- *1) Be sure to use a dehumidifier such as electronic cooler for NO, SO₂, and CO analyzers of 0 to 200 ppm range (≒2°C saturation or lower).
- *2) Be sure to use auto zero calibration, in the case of 500 ppm or less range.

List of sampling devices (example)

No.	Device name	Fuji's type
①	Mist filter	ZBBK1V03-0
②	Safety drain trap	ZBH51603
③	Pump	ZBG80
④	Electronic cooler	ZBC91003
⑤	Drain pot	ZBH13003 (Length 255mm)
⑥	Ball valve	ZBFB1
⑦	Two-way solenoid valve	
⑧	Standard gas for calibration	ZBM□Y04-0□ (Codes in □ to be selected depending on application)
⑨	Flow meter	ZBD42203
⑩	Membrane filter	ZBBM2V03-0
⑪	Demister	ZBH35003
⑫	NO ₂ /NO converter	ZDL02001
⑬	Three-way solenoid valve	

Note) The above is a typical configuration example. As configuration may differ depending on measuring objects, please consult us.

Digit	Description	note	1	2	3	4	5	6	7	8	9	10	11	12	13	14	15	16	17	18	19	20	21	22	23	24	25	26	← Digit
24	<Unit> ppm, % mg/m ³ , g/m ³	note7	Z	R	E					1																			
25	<Adjustment> For standard For heat treatment furnace For converter Others	note8																											
26	<Others> None standard																												

<RANGE CODE>	
Range	Code
None	Y
0-100ppm	B
0-200ppm	C
0-250ppm	D
0-300ppm	S
0-500ppm	E
0-1000ppm	F
0-2000ppm	G
0-2500ppm	U
0-3000ppm	T
0-5000ppm	H
0-1%	J
0-2%	K
0-3%	Q
0-5%	L
0-10%	M
0-20%	N
0-25%	V
0-40%	W
0-50%	P
0-70%	X
0-100%	R
Others	Z

- note1) "A. Cal." must be specified at 22nd digit, in the case of 500 ppm or less range.
- note2) When only O₂ measurement is necessary, "Y" should be specified at the 6th digit.
- note3) When "1" is specified at 7th digit, O₂ pt sensor signal has to be set as 0-1V DC linear corresponding to full scale.
External zirconia O₂ sensor and external O₂ analyzer are not included in the scope of supply, and has to be separately ordered.
- note4) Refer to Tables 1 for possible combination of measuring components and ranges in the data sheet.
When "Y" is specified at 6th digit, "Y" should be specified at 9th to 16th digit.
- note5) O₂ correction is calculated only for NO, SO₂ and CO
- note6) When 5 components measurement is specified, "H" must not be specified at 22nd digit.
When 4 components measurement is specified and "H" is specified at 22nd digit, 3 point is maximum for alarm output function.
- note7) When "B" is specified at 24th digit, measuring range should be specified by ppm range code.
In this case NO, SO₂ and CO measuring range are corresponding range in mg/m³.
Please refer to the table shown below for the corresponding range code based on "mg/m³".
- note8) When A to D is specified on the 25th digit, the analyzer will be adjusted and delivered with the following gasses.
Standard "A": balance gas N₂
For heat treatment furnace "C": balance gas 30%H₂ / remains N₂
For converter "D": balance gas CO, CO₂
When other adjustment is required, please specify "Z";
When "Z" is specified, please attach a list of gas composition contained in the measuring gas.

Corresponding mg/m³

Range code	Unit : ppm	Corresponding range in mg/m ³		
		NO	SO ₂	CO
C	0-200ppm	0-260mg/m ³	0-570mg/m ³	0-250mg/m ³
D	0-250ppm	0-325mg/m ³	0-700mg/m ³	0-300mg/m ³
S	0-300ppm	0-400mg/m ³	0-850mg/m ³	0-375mg/m ³
E	0-500ppm	0-650mg/m ³	0-1400mg/m ³	0-600mg/m ³
F	0-1000ppm	0-1300mg/m ³	0-2800mg/m ³	0-1250mg/m ³
G	0-2000ppm	0-2600mg/m ³	0-5600mg/m ³	0-2500mg/m ³

The conversion formula "ppm" unit into "mg/m³" unit.
 NO (mg/m³) = 1.34 × NO (ppm)
 SO₂ (mg/m³) = 2.86 × SO₂ (ppm)
 CO (mg/m³) = 1.25 × CO (ppm)

Table 1 Measurable component and range - availability check table -

Procedure of range selection

On one component analyzer:

First determine 1st range, then select 2nd range from the right of your determination range in following tables.

More than two components:

The procedure is same as one component. Difference is 2nd range in the tables.

The 2nd range in the tables for two and more components is maximum available range.

2nd range is selectable from 1st range to 2nd range(max) on the table.

1-component analyzer : CO

1st range	2nd range
0 - 200ppm	None, 0 - 250ppm,300ppm,500ppm,1000ppm,2000ppm
0 - 250ppm	None, 0 - 300ppm,500ppm,1000ppm,2000ppm,2500ppm
0 - 300ppm	None, 0 - 500ppm,1000ppm,2000ppm,2500ppm
0 - 500ppm	None, 0 - 1000ppm,2000ppm,2500ppm,3000ppm,5000ppm
0 - 1000ppm	None, 0 - 2000ppm,2500ppm,3000ppm,5000ppm,1%
0 - 2000ppm	None, 0 - 2500ppm,3000ppm,5000ppm,1%,2%
0 - 2500ppm	None, 0 - 3000ppm,5000ppm,1%,2%
0 - 3000ppm	None, 0 - 5000ppm,1%,2%
0 - 5000ppm	None, 0 - 1%,2%,3%,5%
0 - 1%	None, 0 - 2%,3%,5%,10%
0 - 2%	None, 0 - 3%,5%,10%,20%
0 - 3%	None, 0 - 5%,10%,20%,25%
0 - 5%	None, 0 - 10%,20%,25%,40%,50%
0 - 10%	None, 0 - 20%,25%,40%,50%,70%,100%
0 - 20%	None, 0 - 25%,40%,50%,70%,100%
0 - 25%	None, 0 - 40%,50%,70%,100%
0 - 40%	None, 0 - 50%,70%,100%
0 - 50%	None, 0 - 70%,100%
0 - 70%	None, 0 - 100%
0 - 100%	None

1-component analyzer : NO

1st range	2nd range
0 - 200ppm	None, 0 - 250ppm,300ppm,500ppm,1000ppm,2000ppm
0 - 250ppm	None, 0 - 300ppm,500ppm,1000ppm,2000ppm,2500ppm
0 - 300ppm	None, 0 - 500ppm,1000ppm,2000ppm,2500ppm
0 - 500ppm	None, 0 - 1000ppm,2000ppm,2500ppm,3000ppm,5000ppm
0 - 1000ppm	None, 0 - 2000ppm,2500ppm,3000ppm,5000ppm
0 - 2000ppm	None, 0 - 2500ppm,3000ppm,5000ppm
0 - 2500ppm	None, 0 - 3000ppm,5000ppm
0 - 3000ppm	None, 0 - 5000ppm

1-component analyzer : SO₂

1st range	2nd range
0 - 200ppm	None, 0 - 250ppm,300ppm,500ppm,1000ppm,2000ppm
0 - 250ppm	None, 0 - 300ppm,500ppm,1000ppm,2000ppm,2500ppm
0 - 300ppm	None, 0 - 500ppm,1000ppm,2000ppm,2500ppm
0 - 500ppm	None, 0 - 1000ppm,2000ppm,2500ppm,3000ppm,5000ppm
0 - 1000ppm	None, 0 - 2000ppm,2500ppm,3000ppm,5000ppm,1%
0 - 2000ppm	None, 0 - 2500ppm,3000ppm,5000ppm,1%,2%
0 - 2500ppm	None, 0 - 3000ppm,5000ppm,1%,2%
0 - 3000ppm	None, 0 - 5000ppm,1%,2%
0 - 5000ppm	None, 0 - 1%,2%,3%,5%
0 - 1%	None, 0 - 2%,3%,5%,10%
0 - 2%	None, 0 - 3%,5%,10%
0 - 3%	None, 0 - 10%
0 - 5%	None

1-component analyzer : CO₂

1st range	2nd range
0 - 100ppm	None, 0 - 200ppm,250ppm,300ppm,500ppm,1000ppm
0 - 200ppm	None, 0 - 250ppm,300ppm,500ppm,1000ppm,2000ppm
0 - 250ppm	None, 0 - 300ppm,500ppm,1000ppm,2000ppm,2500ppm
0 - 300ppm	None, 0 - 500ppm,1000ppm,2000ppm,2500ppm
0 - 500ppm	None, 0 - 1000ppm,2000ppm,2500ppm,3000ppm,5000ppm
0 - 1000ppm	None, 0 - 2000ppm,2500ppm,3000ppm,5000ppm,1%
0 - 2000ppm	None, 0 - 2500ppm,3000ppm,5000ppm,1%,2%
0 - 2500ppm	None, 0 - 3000ppm,5000ppm,1%,2%
0 - 3000ppm	None, 0 - 5000ppm,1%,2%
0 - 5000ppm	None, 0 - 1%,2%,3%,5%
0 - 1%	None, 0 - 2%,3%,5%,10%
0 - 2%	None, 0 - 3%,5%,10%,20%
0 - 3%	None, 0 - 5%,10%,20%,25%
0 - 5%	None, 0 - 10%,20%,25%,40%,50%
0 - 10%	None, 0 - 20%,25%,40%,50%,75%,100%
0 - 20%	None, 0 - 25%,40%,50%,75%,100%
0 - 25%	None, 0 - 40%,50%,75%,100%
0 - 40%	None, 0 - 50%,75%,100%
0 - 50%	None, 0 - 75%,100%
0 - 70%	None, 0 - 100%
0 - 100%	None

1-component analyzer : CH₄

1st range	2nd range
0 - 500ppm	None, 0 - 1000ppm,2000ppm,2500ppm,3000ppm,5000ppm
0 - 1000ppm	None, 0 - 2000ppm,2500ppm,3000ppm,5000ppm,1%
0 - 2000ppm	None, 0 - 2500ppm,3000ppm,5000ppm,1%,2%
0 - 2500ppm	None, 0 - 3000ppm,5000ppm,1%,2%
0 - 3000ppm	None, 0 - 5000ppm,1%,2%
0 - 5000ppm	None, 0 - 1%,2%,3%,5%
0 - 1%	None, 0 - 2%,3%,5%,10%
0 - 2%	None, 0 - 3%,5%,10%,20%
0 - 3%	None, 0 - 5%,10%,20%,25%
0 - 5%	None, 0 - 10%,20%,25%,40%,50%
0 - 10%	None, 0 - 20%,25%,40%,50%,70%,100%
0 - 20%	None, 0 - 25%,40%,50%,70%,100%
0 - 25%	None, 0 - 40%,50%,70%,100%
0 - 40%	None, 0 - 50%,70%,100%
0 - 50%	None, 0 - 70%,100%
0 - 70%	None, 0 - 100%
0 - 100%	None

2-component analyzer : NO/SO₂

1-component : NO		2-component : SO ₂	
1st range	2nd range (max.)	1st range	2nd range (max.)
0 - 200ppm	0 - 2000ppm	0 - 200ppm	0 - 2000ppm
0 - 250ppm	0 - 2500ppm	0 - 250ppm	0 - 2500ppm
0 - 300ppm	0 - 2500ppm	0 - 300ppm	0 - 2500ppm
0 - 500ppm	0 - 5000ppm	0 - 500ppm	0 - 5000ppm
0 - 1000ppm	0 - 5000ppm	0 - 1000ppm	0 - 5000ppm
0 - 2000ppm	0 - 5000ppm	0 - 2000ppm	0 - 5000ppm
0 - 2500ppm	0 - 5000ppm	0 - 2500ppm	0 - 5000ppm
0 - 3000ppm	0 - 5000ppm	0 - 3000ppm	0 - 5000ppm
0 - 5000ppm	None	0 - 5000ppm	None

• The 2nd component should be selected as shown in the right table.

2-component analyzer : NO/CO

1-component : NO		2-component : CO	
1st range	2nd range (max.)	1st range	2nd range (max.)
0 - 200ppm	0 - 2000ppm	0 - 200ppm	0 - 2000ppm
0 - 250ppm	0 - 2500ppm	0 - 250ppm	0 - 2500ppm
0 - 300ppm	0 - 2500ppm	0 - 300ppm	0 - 2500ppm
0 - 500ppm	0 - 5000ppm	0 - 500ppm	0 - 5000ppm
0 - 1000ppm	0 - 5000ppm	0 - 1000ppm	0 - 5000ppm
0 - 2000ppm	0 - 5000ppm	0 - 2000ppm	0 - 5000ppm
0 - 2500ppm	0 - 5000ppm	0 - 2500ppm	0 - 5000ppm
0 - 3000ppm	0 - 5000ppm	0 - 3000ppm	0 - 5000ppm
0 - 5000ppm	None	0 - 5000ppm	None

• The 2nd component should be selected as shown in the right table.

2-component analyzer : CO₂/CO

1-component : CO ₂		2-component : CO
1st range	2nd range (max.)	1st range/2nd range (max.)
0 - 100ppm	0 - 1000ppm	0 - 200/2000ppm,250/2500ppm,300/2500ppm,500/5000ppm,1000ppm/1%,2000ppm/2%, 0 - 2500ppm/2%,3000ppm/2%,5000ppm/5%,1/10%,2/20%
0 - 200ppm	0 - 2000ppm	
0 - 250ppm	0 - 2500ppm	
0 - 300ppm	0 - 2500ppm	
0 - 500ppm	0 - 5000ppm	0 - 200/2000ppm,250/2500ppm,300/2500ppm,500/5000ppm,1000ppm/1%,2000ppm/2%, 0 - 2500ppm/2%,3000ppm/2%,5000ppm/5%,1/10%,2/20%,3/5%,5/50%
0 - 1000ppm	0 - 1%	
0 - 2000ppm	0 - 2%	
0 - 2500ppm	0 - 2%	0 - 200/2000ppm,250/2500ppm,300/2500ppm,500/5000ppm,1000ppm/1%,2000ppm/2%, 0 - 2500ppm/2%,3000ppm/2%,5000ppm/5%,1/10%,2/20%,3/5%,5/50%
0 - 3000ppm	0 - 2%	
0 - 5000ppm	0 - 5%	
0 - 1%	0 - 10%	
0 - 2%	0 - 20%	0 - 10/100%,20/100%,25/100%,40/100%,50/100%,70/100%,100%/None
0 - 3%	0 - 25%	
0 - 5%	0 - 50%	
0 - 10%	0 - 100%	
0 - 20%	0 - 100%	0 - 3/25%,5/50%,10/100%,20/100%,25/100%,40/100%,50/100%,70/100%,100%/None
0 - 25%	0 - 100%	
0 - 40%	0 - 100%	
0 - 50%	0 - 100%	
0 - 70%	0 - 100%	
0 - 100%	None	

2-component analyzer : CH₄/CO

1-component : CH ₄		2-component : CO
1st range	2nd range (max.)	1st range/2nd range (max.)
0 - 500ppm	0 - 5000ppm	0 - 200/2000ppm,250/2500ppm,300/2500ppm,500/5000ppm,1000ppm/1%,2000ppm/2%, 0 - 2500ppm/2%,3000ppm/2%,5000ppm/5%
0 - 1000ppm	0 - 1%	
0 - 2000ppm	0 - 2%	0 - 200/2000ppm,250/2500ppm,300/2500ppm,500/5000ppm,1000ppm/1%,2000ppm/2%, 0 - 2500ppm/2%,3000ppm/2%,5000ppm/5%,1/10%,
0 - 2500ppm	0 - 2%	
0 - 3000ppm	0 - 2%	0 - 200/2000ppm,250/2500ppm,300/2500ppm,500/5000ppm,1000ppm/1%,2000ppm/2%, 0 - 2500ppm/2%,3000ppm/2%,5000ppm/5%,1/10%,2/20%,3/25%
0 - 5000ppm	0 - 5%	
0 - 1%	0 - 10%	0 - 200/2000ppm,250/2500ppm,300/2500ppm,500/5000ppm,1000ppm/1%,2000ppm/2%, 0 - 2500ppm/2%,3000ppm/2%,5000ppm/5%,1/10%,2/20%,3/25%,5/50%,10/100%,20/100%, 0 - 25/100%,40/100%,50/100%,70/100%,100%/None
0 - 2%	0 - 20%	
0 - 3%	0 - 25%	
0 - 5%	0 - 50%	
0 - 10%	0 - 100%	
0 - 20%	0 - 100%	
0 - 25%	0 - 100%	
0 - 40%	0 - 100%	
0 - 50%	0 - 100%	
0 - 70%	0 - 100%	
0 - 100%	None	

2-component analyzer : CO₂/CH₄

1-component : CO ₂		2-component : CH ₄
1st range	2nd range (max.)	1st range/2nd range (max.)
0 - 100ppm	0 - 1000ppm	0 - 500/5000ppm,1000ppm/1%,2000ppm/2%
0 - 200ppm	0 - 2000ppm	
0 - 250ppm	0 - 2500ppm	
0 - 300ppm	0 - 2500ppm	
0 - 500ppm	0 - 5000ppm	0 - 500/5000ppm,1000ppm/1%,2000ppm/2%,500ppm/2%,5000ppm/5%,1/10%
0 - 1000ppm	0 - 1%	
0 - 2000ppm	0 - 2%	0 - 500/5000ppm,1000ppm/1%,2000ppm/2%,2500ppm/2%,5000ppm/5%,1/10%
0 - 2500ppm	0 - 2%	
0 - 3000ppm	0 - 2%	0 - 500/5000ppm,1000ppm/1%,2000ppm/2%,2500ppm/2%,5000ppm/5%,1/10%
0 - 5000ppm	0 - 5%	
0 - 1%	0 - 10%	0 - 2/20%,3/25%,5/50%
0 - 2%	0 - 20%	
0 - 3%	0 - 25%	
0 - 5%	0 - 50%	
0 - 10%	0 - 100%	
0 - 20%	0 - 100%	
0 - 25%	0 - 100%	
0 - 40%	0 - 100%	
0 - 50%	0 - 100%	
0 - 70%	0 - 100%	
0 - 100%	None	

3-component analyzer : NO/SO₂/CO

1-component : NO		+	2-component : SO ₂		+	3-component : CO	
1st range	2nd range (max.)		1st range	2nd range (max.)		1st range	2nd range (max.)
0 - 200ppm	0 - 2000ppm		0 - 200ppm	0 - 2000ppm		0 - 200ppm	0 - 2000ppm
0 - 250ppm	0 - 2500ppm		0 - 250ppm	0 - 2500ppm		0 - 250ppm	0 - 2500ppm
0 - 300ppm	0 - 2500ppm		0 - 300ppm	0 - 2500ppm		0 - 300ppm	0 - 2500ppm
0 - 500ppm	0 - 5000ppm		0 - 500ppm	0 - 5000ppm		0 - 500ppm	0 - 5000ppm
0 - 1000ppm	0 - 5000ppm		0 - 1000ppm	0 - 5000ppm		0 - 1000ppm	0 - 5000ppm
0 - 2000ppm	0 - 5000ppm		0 - 2000ppm	0 - 5000ppm		0 - 2000ppm	0 - 5000ppm
0 - 2500ppm	0 - 5000ppm		0 - 2500ppm	0 - 5000ppm		0 - 2500ppm	0 - 5000ppm
0 - 3000ppm	0 - 5000ppm		0 - 3000ppm	0 - 5000ppm		0 - 3000ppm	0 - 5000ppm
0 - 5000ppm	None		0 - 5000ppm	None		0 - 5000ppm	None

3-component analyzer : CO₂/CO/CH₄

1-component : CO ₂		2-component : CO		+	3-component : CH ₄		Availability of product
1st range	2nd range (max.)	1st range/2nd range (max.)			1st range	2nd range (max.)	
0 - 5000ppm	0 - 5%	0 - 500/5000ppm,1000ppm/1%,2000ppm/2%,2500ppm/2%,3000ppm/2%,			0 - 5000ppm	0 - 5%	Product available
0 - 1%	0 - 10%	0 - 5000ppm/5%,1%/10%,2%/20%,3%/25%,5%/50%			0 - 1%	0 - 10%	
0 - 2%	0 - 20%	0 - 500/5000ppm,1000ppm/1%,2000ppm/2%,2500ppm/2%,3000ppm/2%,			0 - 2%	0 - 20%	
0 - 3%	0 - 25%	0 - 5000ppm/5%,1/10%,2/20%,3/25%,5/50%,10/100%,20/100%,25/100%,			0 - 3%	0 - 25%	Product available only when CO analyzer measuring range is 0 to 1000ppm or more.
0 - 5%	0 - 50%	0 - 40/100%,50/100%,70/100%,100/None			0 - 5%	0 - 50%	
0 - 10%	0 - 100%	0 - 1000ppm/1%,2000ppm/2%,2500ppm/2%,3000ppm/2%,5000ppm/5%,			0 - 10%	0 - 100%	Product available only when CO analyzer measuring range is 0 to 5000ppm or more.
0 - 20%	0 - 100%	0 - 1/10%,2/20%,3/25%,5/50%,10/100%,20/100%,25/100%,40/100%,			0 - 20%	0 - 100%	
0 - 25%	0 - 100%	0 - 50/100%,70/100%,100/None			0 - 25%	0 - 100%	
0 - 40%	0 - 100%				0 - 40%	0 - 100%	
0 - 50%	0 - 100%				0 - 50%	0 - 100%	
0 - 70%	0 - 100%				0 - 70%	0 - 100%	
0 - 100%	None				0 - 100%	None	

4-component analyzer : NO/SO₂/CO₂/CO

1-component : NO		+	2-component : SO ₂		+	3-component : CO ₂		+	4-component : CO	
1st range	2nd range (max.)		1st range	2nd range (max.)		1st range	2nd range (max.)		1st range	2nd range (max.)
0 - 200ppm	0 - 2000ppm		0 - 200ppm	0 - 2000ppm		0 - 1%	0 - 10%		0 - 200ppm	0 - 2000ppm
0 - 250ppm	0 - 2500ppm		0 - 250ppm	0 - 2500ppm		0 - 2%	0 - 20%		0 - 250ppm	0 - 2500ppm
0 - 300ppm	0 - 2500ppm		0 - 300ppm	0 - 2500ppm		0 - 3%	0 - 25%		0 - 300ppm	0 - 2500ppm
0 - 500ppm	0 - 5000ppm		0 - 500ppm	0 - 5000ppm		0 - 5%	0 - 50%		0 - 500ppm	0 - 2500ppm
0 - 1000ppm	0 - 5000ppm		0 - 1000ppm	0 - 5000ppm		0 - 10%	0 - 50%		0 - 1000ppm	0 - 2500ppm
0 - 2000ppm	0 - 5000ppm		0 - 2000ppm	0 - 5000ppm		0 - 20%	0 - 50%		0 - 2000ppm	0 - 2500ppm
0 - 2500ppm	0 - 5000ppm		0 - 2500ppm	0 - 5000ppm		0 - 25%	0 - 50%		0 - 2500ppm	None
0 - 3000ppm	0 - 5000ppm		0 - 3000ppm	0 - 5000ppm		0 - 25%	0 - 50%			
0 - 5000ppm	None		0 - 5000ppm	None		0 - 50%	None			

Table 2 Channel (Ch) No. and display/output contents comparison table

Code symbol			Display/output contents
6th digit	7th digit	21st digit	
Y	1 to 3	Y	Ch1:O ₂
P	Y	Y	Ch1:NO
A	Y	Y	Ch1:SO ₂
D	Y	Y	Ch1:CO ₂
B	Y	Y	Ch1:CO
E	Y	Y	Ch1:CH ₄
F	Y	Y	Ch1:NO, Ch2:SO ₂
G	Y	Y	Ch1:NO, Ch2:CO
J	Y	Y	Ch1:CO ₂ , Ch2:CO
K	Y	Y	Ch1:CH ₄ , Ch2:CO
L	Y	Y	Ch1:CO ₂ , Ch2:CH ₄
N	Y	Y	Ch1:NO, Ch2:SO ₂ , Ch3:CO
T	Y	Y	Ch1:CO ₂ , Ch2:CO, Ch3:CH ₄
V	Y	Y	Ch1:NO, Ch2:SO ₂ , Ch3:CO ₂ , Ch4:CO
P	1 to 3	Y	Ch1:NO, Ch2:O ₂
A	1 to 3	Y	Ch1:SO ₂ , Ch2:O ₂
D	1 to 3	Y	Ch1:CO ₂ , Ch2:O ₂
B	1 to 3	Y	Ch1:CO, Ch2:O ₂
E	1 to 3	Y	Ch1:CH ₄ , Ch2:O ₂
F	1 to 3	Y	Ch1:NO, Ch2:SO ₂ , Ch3:O ₂
G	1 to 3	Y	Ch1:NO, Ch2:CO, Ch3:O ₂
J	1 to 3	Y	Ch1:CO ₂ , Ch2:CO, Ch3:O ₂
K	1 to 3	Y	Ch1:CH ₄ , Ch2:CO, Ch3:O ₂
L	1 to 3	Y	Ch1:CO ₂ , Ch2:CH ₄ , Ch3:O ₂
N	1 to 3	Y	Ch1:NO, Ch2:SO ₂ , Ch3:CO, Ch4:O ₂
T	1 to 3	Y	Ch1:CO ₂ , Ch2:CO, Ch3:CH ₄ , Ch4:O ₂
V	1 to 3	Y	Ch1:NO, Ch2:SO ₂ , Ch3:CO ₂ , Ch4:CO, Ch5:O ₂
P	1 to 3	A *	Ch1:NO _x , Ch2:O ₂ , Ch3:corrected NO _x
A	1 to 3	A *	Ch1:SO ₂ , Ch2:O ₂ , Ch3:corrected SO ₂
B	1 to 3	A *	Ch1:CO, Ch2:O ₂ , Ch3:corrected CO
F	1 to 3	A *	Ch1:NO _x , Ch2:SO ₂ , Ch3:O ₂ , Ch4:corrected NO _x , Ch5:corrected SO ₂
G	1 to 3	A *	Ch1:NO _x , Ch2:CO, Ch3:O ₂ , Ch4:corrected NO _x , Ch5:corrected CO
J	1 to 3	A *	Ch1:CO ₂ , Ch2:CO, Ch3:O ₂ , Ch4:corrected CO
N	1 to 3	A *	Ch1:NO _x , Ch2:SO ₂ , Ch3:CO, Ch4:O ₂ , Ch5:corrected NO _x , Ch6:corrected SO ₂ , Ch7:corrected CO
V	1 to 3	A *	Ch1:NO _x , Ch2:SO ₂ , Ch3:CO ₂ , Ch4:CO, Ch5:O ₂ , Ch6:corrected NO _x , Ch7:corrected SO ₂ , Ch8:corrected CO
P	1 to 3	C *	Ch1:NO _x , Ch2:O ₂ , Ch3:corrected NO _x , Ch4:corrected NO _x average
A	1 to 3	C *	Ch1:SO ₂ , Ch2:O ₂ , Ch3:corrected SO ₂ , Ch4:corrected SO ₂ average
B	1 to 3	C *	Ch1:CO, Ch2:O ₂ , Ch3:corrected CO, Ch4:corrected CO average
F	1 to 3	C *	Ch1:NO _x , Ch2:SO ₂ , Ch3:O ₂ , Ch4:corrected NO _x , Ch5:corrected SO ₂ , Ch6:corrected NO _x average, Ch7:corrected SO ₂ average
G	1 to 3	C *	Ch1:NO _x , Ch2:CO, Ch3:O ₂ , Ch4:corrected NO _x , Ch5:corrected CO, Ch6:corrected NO _x average, Ch7:corrected CO average
J	1 to 3	C *	Ch1:CO ₂ , Ch2:CO, Ch3:O ₂ , Ch4:corrected CO, Ch5:corrected CO average
N	1 to 3	C *	Ch1:NO _x , Ch2:SO ₂ , Ch3:CO, Ch4:O ₂ , Ch5:corrected NO _x , Ch6:corrected SO ₂ , Ch7:corrected CO, Ch8:corrected NO _x average, Ch9:corrected SO ₂ average, Ch10:corrected CO average
V	1 to 3	C *	Ch1:NO _x , Ch2:SO ₂ , Ch3:CO ₂ , Ch4:CO, Ch5:O ₂ , Ch6:corrected NO _x , Ch7:corrected SO ₂ , Ch8:corrected CO, Ch9:corrected NO _x average, Ch10:corrected SO ₂ average, Ch11:corrected CO average

* When the 21st digit code is A or C, the component of the NO analyzer is displayed as NO_x.

OUTLINE DIAGRAMS (Unit : mm)

<Top view>

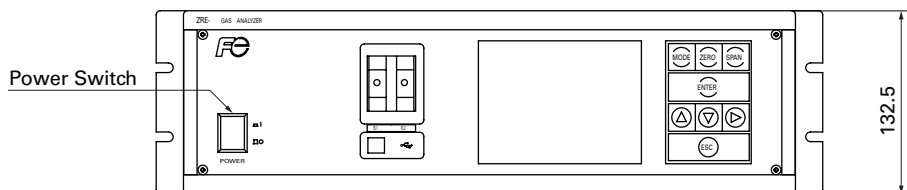
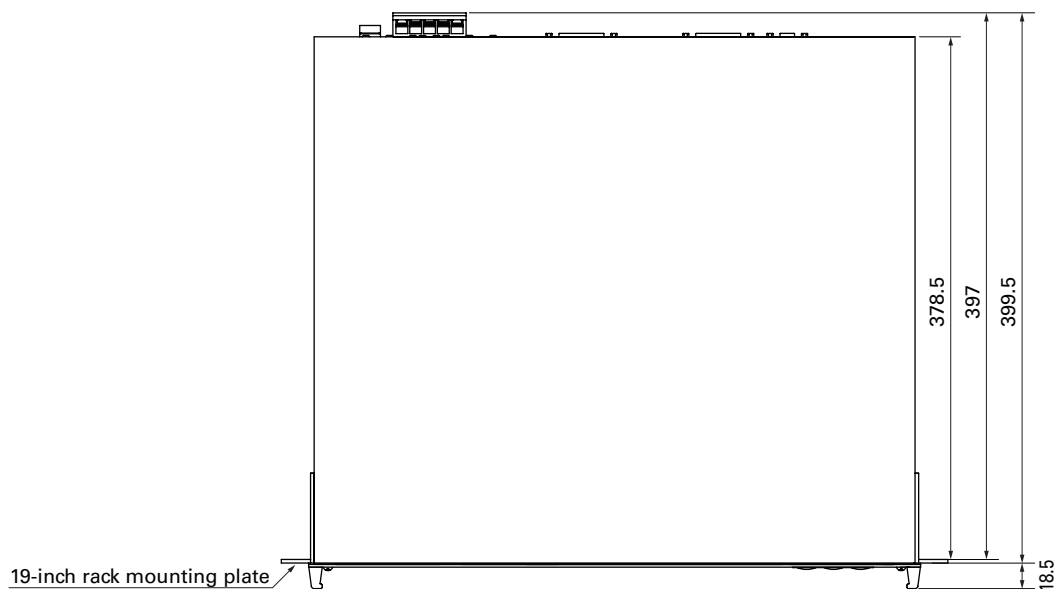

<Front view>

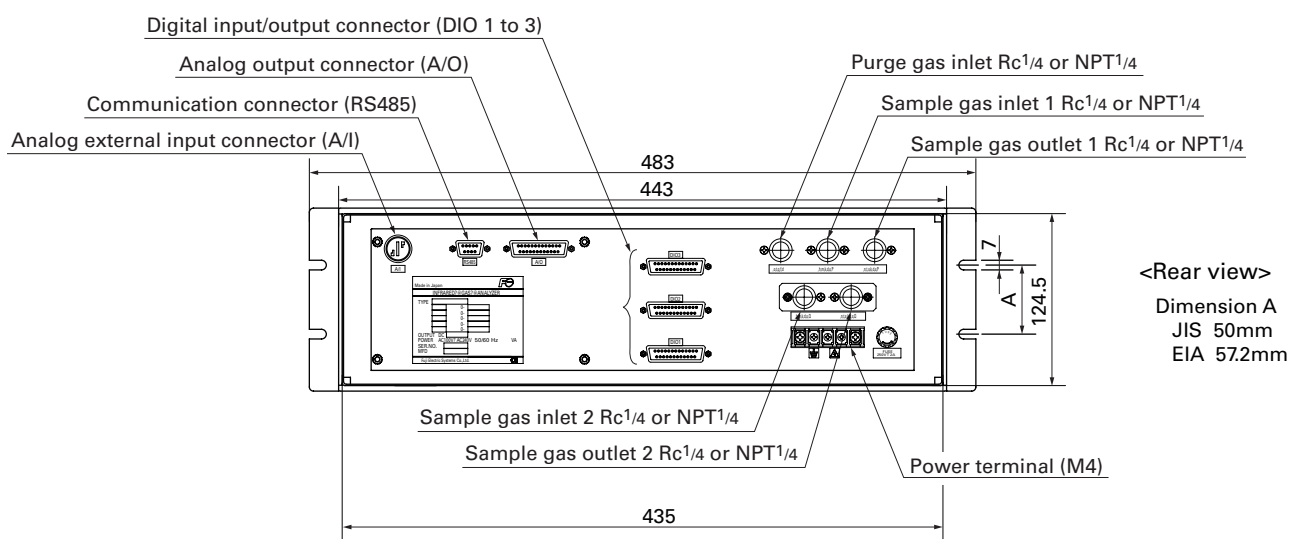

Mounting method

The analyzer weight should be supported at the bottom of the case.

Panel mounting type

<Panel cutout dimensions>

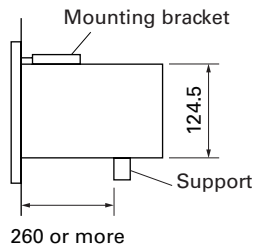
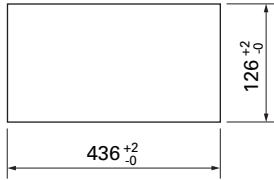

* 70% or more of the analyzer weight should be supported at the bottom of the case. (In case of mounting panel or 19-inch rack provide a support at the end of casing.)

19-inch rack mounting type

<Rack dimensions>

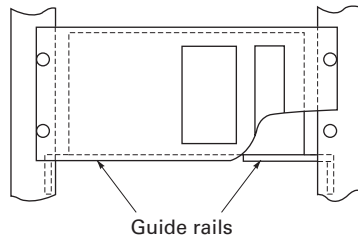
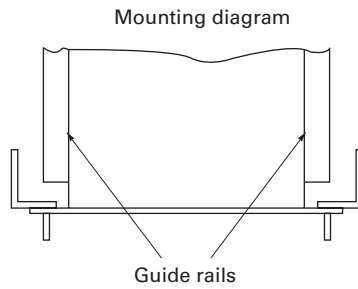
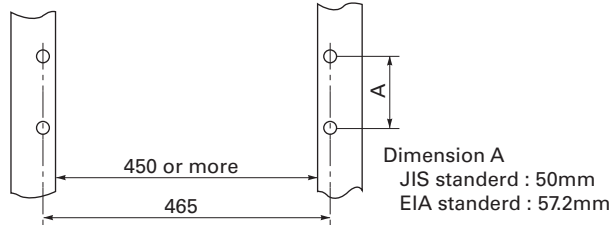

EXTERNAL CONNECTION

<Analog output> A/O connector

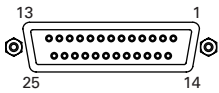

D-sub 25pins female

* In standard, displayed Channel No. and Analog Output No. are same.

- ① — A01+
- ② — A01-
- ③ — A02+
- ④ — A02-
- ⑤ — A03+
- ⑥ — A03-
- ⑦ — A04+
- ⑧ — A04-
- ⑨ — A05+
- ⑩ — A05-
- ⑪ — A06+
- ⑫ — A06-
- ⑬ — A07+
- ⑭ — A07-
- ⑮ — A08+
- ⑯ — A08-
- ⑰ — A09+
- ⑱ — A09-
- ⑲ — A010+
- ⑳ — A010-
- ㉑ — A011+
- ㉒ — A011-
- ㉓ — A012+
- ㉔ — A012-
- ㉕ — NC

<RS485 communication signal>

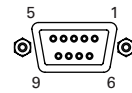

D-sub 9pins female

* When between pin ③ and pin ④ are short-circuited, 120Ω termination resistance is installed between data lines.

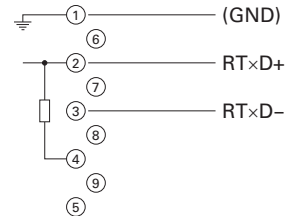

<Power terminal>

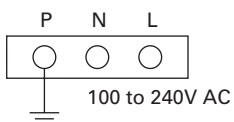

<Analog input> A/I connector (O₂ signal input)

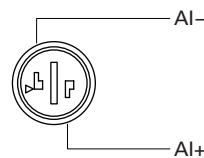

<Digital I/O> DIO 1 to 3 connector (option)

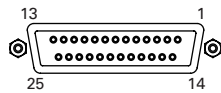

D-sub 25pins female

* DIO 1 to 3 are all as same connector.

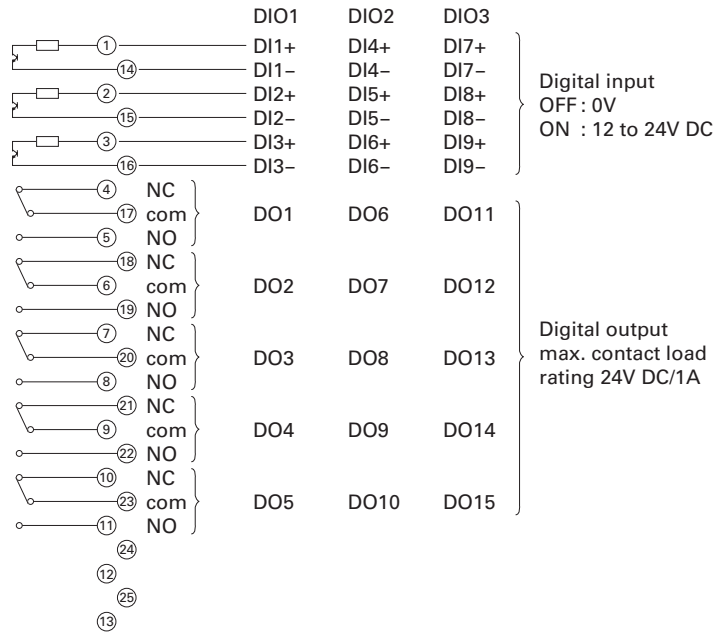

Contents of digital input signal

DI1	Remote hold
DI2	Average value reset
DI3	A. cal. start
DI4	A. zero. cal. start
DI5	Remote range Ch1
DI6	Remote range Ch2
DI7	Remote range Ch3
DI8	Remote range Ch4
DI9	Remote range Ch5

Contents of digital output signal

	1 to 3-component analyzer
22th digit →	A,B,C,D,E,F,G,H
DO1	Instrument error
DO2	Calibration error
DO3	(A. cal. status)
DO4	(For zero gas)
DO5	(For spangas Ch1)
DO6	(For spangas Ch2)
DO7	(For spangas Ch3)
DO8	(Range identification 3)
DO9	(Range identification 2)
DO10	(Range identification 1)
DO11	(Alarm1)
DO12	(Alarm2)
DO13	(Alarm3)
DO14	(Alarm4)
DO15	(Alarm5)

	4-component analyzer			
22th digit →	A,B,C,E	D,G	F	H
DO1	Instrument error	Instrument error	Instrument error	Instrument error
DO2	Calibration error	Calibration error	Calibration error	Calibration error
DO3	(A. cal. status)	(A. cal. status)		A. cal. status
DO4	(For zero gas)	(For zero gas)		For zero gas
DO5	(For spangas Ch1)	(For spangas Ch1)		For spangas Ch1
DO6	(For spangas Ch2)	(For spangas Ch2)		For spangas Ch2
DO7	(For spangas Ch3)	(For spangas Ch3)	Range identification 4	For spangas Ch3
DO8	(For spangas Ch4)	(For spangas Ch4)	Range identification 3	For spangas Ch4
DO9			Range identification 2	Range identification 4
DO10			Range identification 1	Range identification 3
DO11	(Alarm1)		Alarm1	Alarm1
DO12	(Alarm2)	(Range identification 4)	Alarm2	Alarm2
DO13	(Alarm3)	(Range identification 3)	Alarm3	Alarm3
DO14	(Alarm4)	(Range identification 2)	Alarm4	Range identification 2
DO15	(Alarm5)	(Range identification 1)	Alarm5	Range identification 1

	5-component analyzer		
22th digit →	A,B,C,E	D,G	F
DO1	Instrument error	Instrument error	Instrument error
DO2	Calibration error	Calibration error	Calibration error
DO3	(A. cal. status)	(A. cal. status)	
DO4	(For zero gas)	(For zero gas)	
DO5	(For spangas Ch1)	(For spangas Ch1)	
DO6	(For spangas Ch2)	(For spangas Ch2)	Range identification 5
DO7	(For spangas Ch3)	(For spangas Ch3)	Range identification 4
DO8	(For spangas Ch4)	(For spangas Ch4)	Range identification 3
DO9	(For spangas Ch5)	(For spangas Ch5)	Range identification 2
DO10			Range identification 1
DO11	(Alarm1)	(Range identification 5)	Alarm1
DO12	(Alarm2)	(Range identification 4)	Alarm2
DO13	(Alarm3)	(Range identification 3)	Alarm3
DO14	(Alarm4)	(Range identification 2)	Alarm4
DO15	(Alarm5)	(Range identification 1)	Alarm5

The items in the parentheses may not be available depending on the selected type on 22th digit.

The normal open side (NO) of digital output is close when the function is active without range ID.

In case of range ID, normal open (NO) side is close with Lo-range.

The normal close (NC) side is close with Hi-range.

SCOPE OF DELIVERY

- Gas analyzer ... 1 unit
- Replacement fuse (250V, 2A AC, delay type) ... 2 pcs
- Instruction manual ... 1 copy
- Connector for I/O connection ... 1 set
- Panel mounting fixtures (in case panel mounting) ... 2 pcs

ORDERING INFORMATION

1. Code symbols
2. Application and composition of sample gas

Exclusive Zirconia O₂ Sensor (to be purchased separately)

For O₂ correction, the gas analyzer ZRE can accept linearized 0 to 1V DC signal coming from analyzer calibrated 0 to 25% O₂ full scale. If the analyzer is not available, Fuji can supply exclusive Zirconia O₂ sensor Model ZFK.

Measuring method:

Zirconia system

Measurable component and measuring range:

Measurable component		Range
O ₂	Oxygen	0 to 25vol%

- Repeatability:** Within ± 0.5% of full scale
- Linearity:** Within ± 1% of full scale
- Zero drift:** Within ± 1% of full scale/week
- Span drift:** Within ± 2% of full scale/week
- Response time:** Approx. 20 seconds (for 90% response)
- Measured gas flow rate:** 0.5 ± 0.25L / min

Remark: The Zirconia system, due to its principle, may produce a measuring error due to relative concentration versus the combustible O₂ gas concentration. Also, a corrosive gas (SO₂ of 250 ppm or more, etc.) may affect the life of the sensor.

Gas inlet/outlet size:

Rc¹/₄ or NPT¹/₄

Power supply: Rated voltage ; 100 to 115V AC or 200 to 240V AC

Rated frequency ; 50Hz/60Hz

Max. rated power; 215VA (during power ON)
65VA (during steady-state operation)

Enclosure: Steel casing, for indoor application

Indication: Temperature indication (LED)

Temperature alarm output:

Contact output 1a contact,
Contact capacity 220V, 1A AC (resistive load)

Outer dimensions (H x W x D):

140 x 170 x 190mm

Mass {weight}: Approx. 3kg

Finish color: Munsell 5Y 7/1

CODE SYMBOLS

1 2 3 4 5 6 7 8 9 10 11 12 13													Description
Z	F	K	7	Y	Y	4	-	Y	0	Y	Y		Measuring method Zirconia method
7		Y		Y								Power supply 100 to 115V AC 50/60Hz(Standard) 100 to 115V AC 50/60Hz(With pot outlet)* 200 to 240V AC 50/60Hz(Standard) 200 to 240V AC 50/60Hz(With pot outlet)* 200 to 240V AC 50/60Hz(CE mark) 200 to 240V AC 50/60Hz (CE mark, with pot outlet)*	
													Gas inlet Rc 1/4 NPT 1/4

*: Select when SO₂ of 250ppm or more is included in measuring gases.

EXTERNAL CONNECTION DIAGRAM

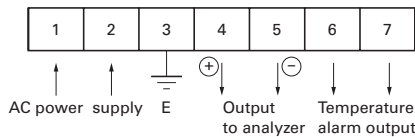

OUTLINE DIAGRAM (Unit:mm)

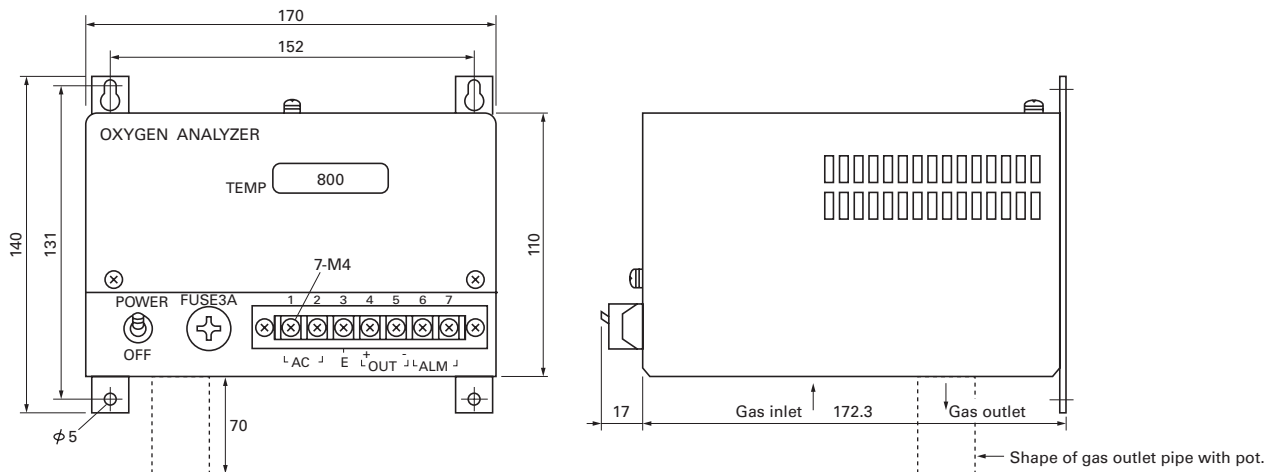

⚠ Caution on Safety

*Before using this product, be sure to read its instruction manual in advance.

Fuji Electric Systems Co.,Ltd.

Head Office

Gate City Ohsaki, East Tower, 11-2, Osaki 1-chome,
Shinagawa-ku, Tokyo 141-0032, Japan
<http://www.fesys.co.jp/eng>

**Instrumentation Div.
International Sales Dept.**

No.1, Fuji-machi, Hino-city, Tokyo, 191-8502 Japan
Phone: 81-42-585-6201, 6202 Fax: 81-42-585-6187
<http://www.fic-net.jp/eng>